

THE INFORMATION CONTAINED IN THIS DRAWING IS THE SOLE PROPERTY OF PHASE TECHNOLOGIES ANY REPRODUCTION IN PART OR WHOLE WITHOUT THE WRITTEN PERMISSION OF Phase Technologies LLC IS PROHIBITED.

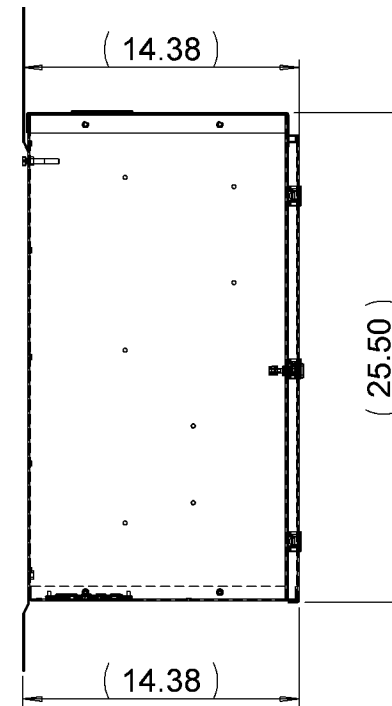
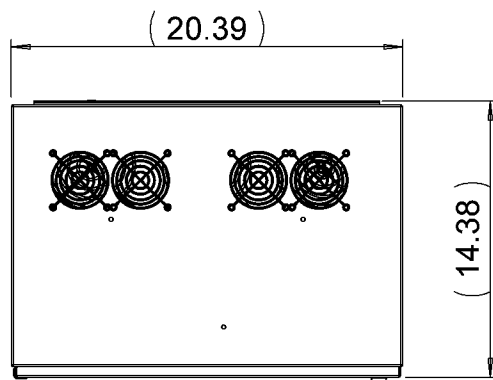
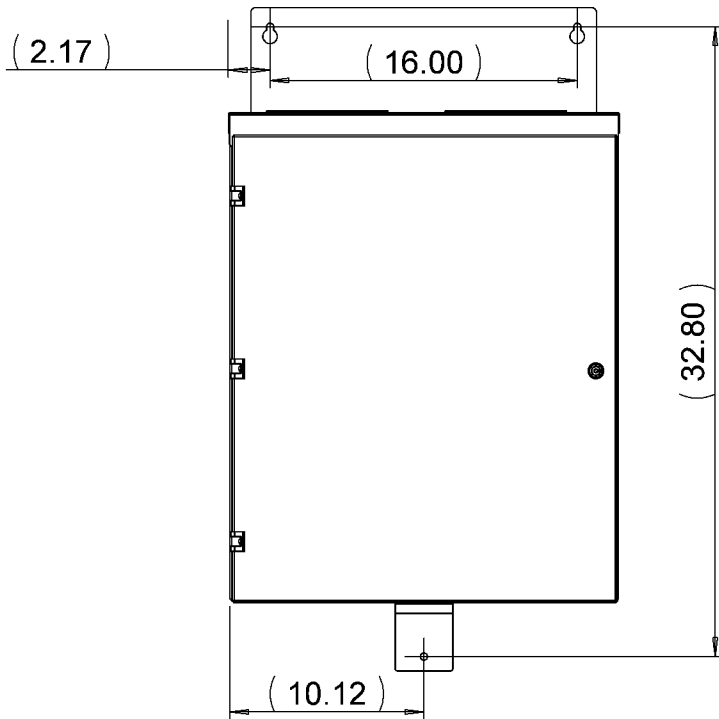

Phase Technologies LLC

APX30
Indoor
V1.0

Date 03/18/2009

SHEET 1 OF 1